

# Instruction Manual

**PULSE ENGINE TACHOMETER** 

**PET-2000DXR / 2100DXR**

This instruction manual is commonly prepared for both PET-2000DXR and PET-2100DXR type of pulse engine tachometers.

## YOUR RECORD OF PURCHASING

(You can use this form to record your purchase details.)

Date of Purchase : Year / Month / Date

Shop Name :

Shop Contact Number :

Shop Address :

Your Name and Contact Information :

**SAMPLE**

This warranty is provided by Oppama Industry Co., Ltd. 14-2, Natsushimacho, Yokosuka, Kanagawa 237-0061, Japan Phone +81-46-866-2139, Fax +81-46-866-3090 E-mail info@oppama.co.jp / http://www.oppama.co.jp

Distributor Details.

## WARRANTY STATEMENT

Oppama Industry Co., Ltd. agree to repair or replace Oppama tachometer with free of charge any when it was found to be defective under normal use and care. Meanwhile, warranty stands void in case of the following :

- Lack of evidence of purchasing in fairly, such as Invoice, Receipt or others.
- Remove the component, such as unscrew a screw, opening the cover etc.
- Given a shock, such as dropping etc. (It is very sensitive product)
- It has been waterlogged. (It is not water proof products)

This warranty is for one year from the date of purchase, and is extended to the original purchaser only and is not transferable.

Instruction to claim the warranty.

- Keep receipt or invoice and fill in the details in this warranty card in every time when you purchase our products.
- Contact with the shop owner or a Oppama distributor in your country or Oppama home page, and inform your problem.
- Provide the products to the person in charge of shop or the distributor with evidence or details of your purchasing.

## IMPORTANT

Complete this warranty card at the time of purchase and keep a copy for your records.

## A.Function

- OPPAMA Pulse Engine Tachometer is of a pulse counting type which detects pulse generated when an ignition plug sparks.
- When this tachometer is used, the maximum R.P.M. of an engine can be measured and stored at two times.
- Therefore, the state of the engine can be diagnosed by comparing the two maximum R.P.M. of the engine.
- This device is provided with an automatic on/off switch function.
- This device can count the number of revolutions of the engine either by contacting or non-contacting means.
- This device is constructed with a waterproof structure so that no water may get into the device during the normal operation of the engine when it is wet in a rain or with spray of water.
- This unit cannot be used for diesel engines and direct ignition engine.

## B.Names of function

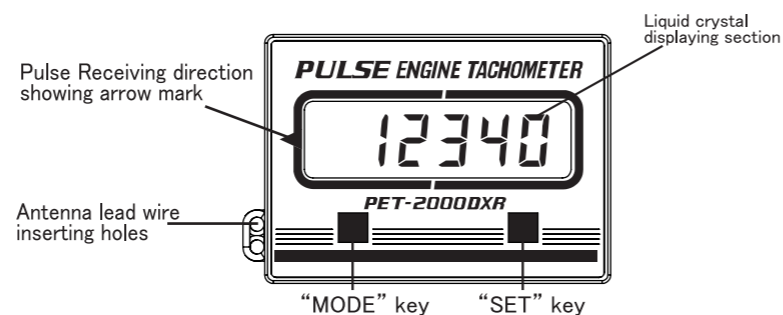

## C.Measuring Position Chart

Position	Objective engine		Measurable range r/min
	Stroke	Cylinder	
P : 41	4	1	100 ~ 30000
※P 21 : 42	2/4	1/2	100 ~ 30000
P : 43	4	3	100 ~ 20000
※P 22 : 44	2/4	2/4	100 ~ 15000
P : 45	4	5	100 ~ 12000
P 23 : 46	2/4	3/6	100 ~ 10000
P 24 : 48	2/4	4/8	100 ~ 7500

Note:※"mark indicates the measuring position of PET-2000DXR tachometer

## D.MODE

- D-1 While non-measuring (When no pulse is inputted)
- Position Mode**  
This mode must be selected at the time of selecting the measuring position of the tachometer against the type of an engine to be measured in accordance with the C. "Measuring Position chart". (Whenever "SET" key is pressed, the selected position is switched to the next position.)  
※Once a position is selected, the position does not change even when the mode is switched to another mode or the tachometer is automatically turned off.
  - Cumulative Time Mode**  
This mode must be selected at the time of displaying the cumulative operating time of the engine. The displayed cumulative operating time can be switched between temporary cumulative time (manually clearable) and total cumulative time (unclearable) by pressing "SET" key.  
The temporary cumulative time can be cleared by simultaneously pressing both "MODE" and "SET" key.  
※The cumulative operating time of some delivered tachometers may not be zero, because of delivery inspections.  
※The principal utilizing examples of the cumulative operating time storing function are as follows:  
• For recording the daily, weekly, or monthly or longer periodical operational history of the engine or equipment mounted with the engine.  
• As a yardstick for judging the periodical servicing timing or inspecting timing of the engine or equipment.  
• For calculating the rental fee or leasing charge of rent or leased equipment based on the actual operating time.
  - Maximum Mode (Maximum R.P.M. Mode)**  
This mode must be selected at the time of displaying the maximum R.P.M. of the engine. The displayed maximum R.P.M. can be cleared by pressing "SET" key.  
※When the maximum R.P.M. are cleared in this mode, the second maximum R.P.M. measured in the dual mode described in (4) below moves to the first maximum R.P.M. displaying section and the second maximum R.P.M. displaying section displays "0".
  - Dual Mode (Dual Maximum R.P.M. display Mode)**  
In this mode, the maximum R.P.M. of the engine respectively measured at the first time and second time are dually displayed.

Fig.1

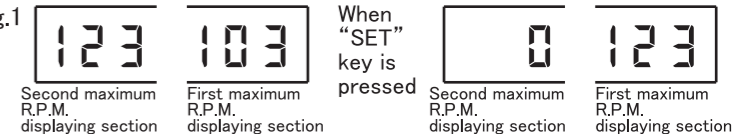

When "SET" key is pressed, the maximum R.P.M. displayed in the second displaying section moves to the first displaying section and the second section display "0".  
※The actual R.P.M. is 100 times of the displayed value.  
※When the maximum R.P.M. in this mode are cleared, the value stored in the maximum mode described in (3) above is also cleared.  
※The maximum R.P.M. displayed in the first maximum R.P.M. display section (no the right side) after the "SET" key is pressed is not clearable. D-2 While measuring (When pulses are inputted)

- Position Mode**  
This mode must be selected at the time of changing the measuring position at measuring time, select the position same as described in (1) "Position Mode" of D-1 "While non-measuring".
- R.P.M. Mode (All tachometers are set to this mode at the factory)**  
This mode must be selected at the time of displaying R.P.M. an engine to be measured. the maximum mode is selected (the maximum R.P.M. is displayed) while "SET" key is pressed.
- Cumulative Time Mode**  
This mode must be selected at the time of displaying the cumulative operating time of the engine at measuring time. The setting method of this mode and the precautions to be taken against this mode are the same as those described in (2) "Cumulative Time Mode" of D-1 "While non-measuring". The cumulative operating time is stored and updated in any mode at measuring time.
- Maximum Mode (Maximum R.P.M. mode)**  
This mode must be selected at the time of displaying the maximum R.P.M. of the engine during measuring. The setting method of this mode and the precautions to be taken against this mode are the same as those described in (3) "Maximum Mode" of D-1 "While non-measuring".  
※The maximum R.P.M. is stored and updated in any mode during measurement.  
※During measurement, the bar at the left upper side of the display flickers as shown in Fig.2.
- Dual Mode (Dual Maximum R.P.M. display Mode)**  
This mode must be selected at the time of displaying the current R.P.M. and maximum R.P.M. of the engine during measurement.

Fig.2

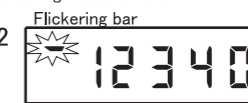
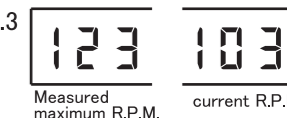

Fig.3



※The actual R.P.M. of the engine is calculated by multiplying the display value by 100. The maximum R.P.M. can be cleared by pressing "SET" key.

## E.How to set Mode

The modes of this tachometer are divided into two cases; during non-measuring time and measuring time. Set a desired mode in accordance with the purpose by referring to the following Key Operation Flow Charts. In addition, perform the key operation (mode switching) while measuring by the tachometer according to Section F "How to Measure" Once a mode is selected, the mode is automatically display depending upon the presence/absent of inputted pulses.

## Key Operation Flow Chart, during non-measuring

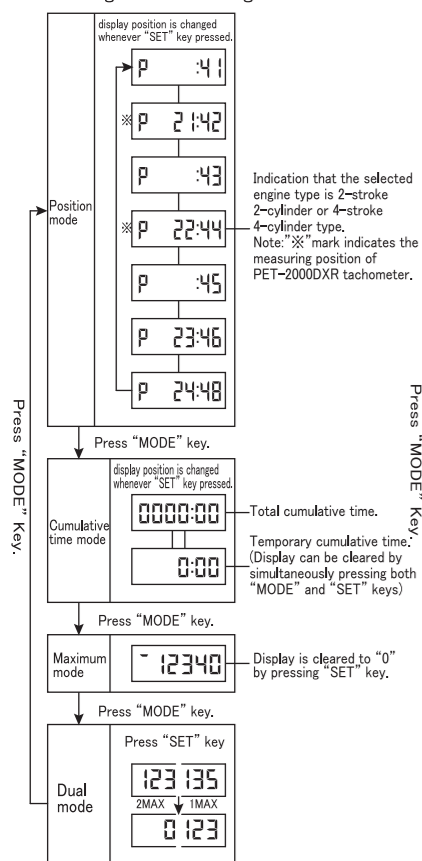

## Key operation Flow Chart, while measuring

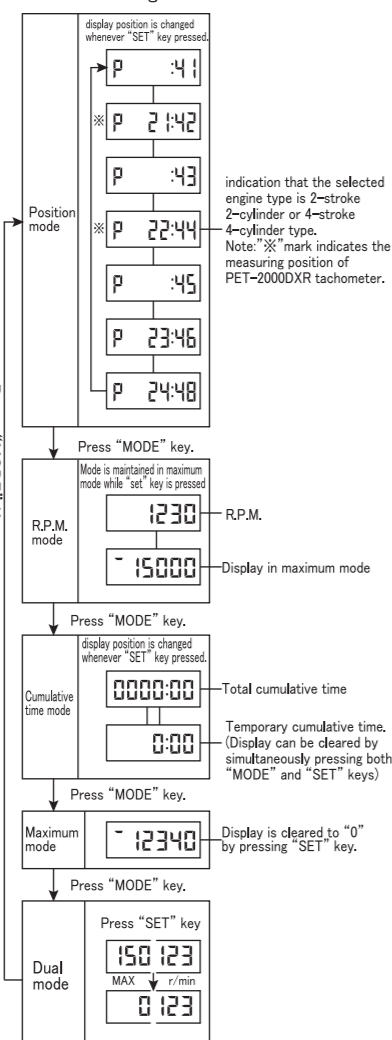

## F. How to Measure

### F-1 Non-contact Measurement

- Turn on the power supply by pressing "MODE" key.
- Select the position mode by referring to Section E "How to set Mode" and select the measuring position corresponding to an engine to be measured.
- Locate the tachometer close to the ignition plug cord of the engine (locate the tachometer from 1cm to 30cm apart from the cord and where the R.P.M. display comes to stable) with the arrow mark pointed to the cord as shown in Fig.4. For a multicylinder engine, locate tachometer close to the binding location of all ignition plug cords. The tachometer displays R.P.M. of the engine while it is held at an appropriate distance.  
※Do not bring the tachometer too close to or into contact with the cord. The tachometer may get out of order.

When the tachometer is moved away from the ignition plug cord of the engine or the engine is stopped, the mode is automatically switched to the mode set while non-measuring time and the displayed contents disappears about one minute later.

### F-2 Contact Measurement

- Attach the antenna lead wire to the tachometer as shown in Fig.5.
- Fix the tachometer to an engine or to an appropriate location of the equipment mounted with the engine with the supplied magic tape. (Velcro tape).
- Attach the antenna lead wire to the ignition plug cord with the clip as shown in Fig.6, or wind the lead wire around the cord three to five turns after removing the clip from the lead wire, and fix the lead wire with an insulating tape, etc. For a multicylinder engine, lay the lead wire so that the wire passes close to all ignition plug cords.
- Select the position mode by referring to Section E "How to set Mode" and the measuring position corresponding to the engine.
- When the engine is started, the tachometer shows R.P.M. of the engine.
- When the engine is stopped, the mode is automatically switched to the mode set while non-measuring time and the display is cleared about one minute later.

**Warning**  
Make sure that your tachometer and antenna lead wire will not obstruct operation of the engine at the time of fixing the tachometer and wiring the lead wire. A serious accident might happen.

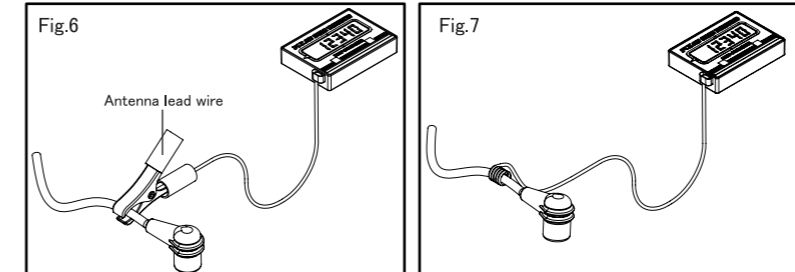
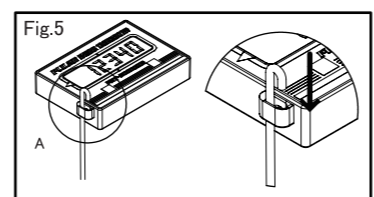
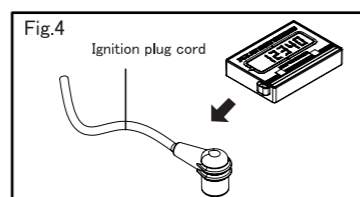

## G. Precautions

### G-1 Signal Detecting Location

- For a multicylinder engine, locate the tachometer close to the location where all ignition plug cords gather, with the arrow mark on the cord side. When the contact measurement is selected, attach the lead wire to one of the cord with the clip or wind the lead wire around the cord and fix the lead wire with an insulating tape, etc. Where the plug cord are separated from each other, the displayed R.P.M. may become erroneous. When this happens, select a pulse detecting location so that antenna lead wire passes close to all ignition plug cords.
- For an automobile engine, etc., provided with a distributor, do not select a location near the distributor or ignition coil as pulse detecting location, because the displayed R.P.M. may become erroneous. For such an engine, select the pulse detecting location so that tachometer will not be affected by the distributor and coil.

### G-2 How to Select "Position"

- The "Position" must be selected on the basis of the basic number of ignitions of an engine to be measured. When plural cylinders are simultaneously ignition in a multicylinder engine, change the measuring "Position".  
Example:  
Select "Position" "P21:42" when the displayed R.P.M. show 1/2 of the true R.P.M. at "Position" "P22:44".
- Some engine have an ignition system which ignites 2 times of normal ignition system. And the displayed R.P.M. show 2 times of the right value, in such a case change the "Position" to the "Position" corresponding to the double number of cylinders.  
Example:  
When R.P.M. measured at "Position" "P21:42" is to be doubled for display, change the "Position" to "P22:44".

- For a four-cycle one-cylinder engine using a magnet-ignition system, try to measure R.P.M. at "Position" "P21:42", because, in many cases, the number of ignition is the same as that of a two-cycle one-cylinder engine.
- The "Position" must be selected carefully, because the cases described in (1) to (3) above may exist in a combined state.

### G-3 Precautions for Use

- Carefully wire the antenna lead wires so that it will not come into contact to much with any metallic part, water, etc., because the pulses are damped and the displayed R.P.M. may become smaller than the proper value.
- When the engine to be measured is of a racing car (especially, kart engine), the display R.P.M. sometimes may become larger than the proper value, because the pulses produced might be stronger than those of ordinary engines.

In such a case, wind the antenna lead wire around a metallic frame, etc., by three to six turns to weaken pulses.

- Do not wind the lead wire excessively, because the displayed R.P.M. may become smaller than the right value.
- The phenomenon described in (2) above may also occur when the ignition plug cord deteriorates with time. In this case, take the same action as that described in (2) above.
- When the non-contact measurement is selected, no measurement is possible when such an obstacle as the finger, etc., exists in front of the pulse receiving direction arrow mark.
- This tachometer is made by waterproof structure and can withstand rains and splash of water under normal operation. However, do not use the tachometer underwater. When the tachometer gets wet with water, remove the water with a piece of dry cloth as soon as possible.
- It may happen, although very rarely, that the stored data are erased depending upon the type of the engine to be measured. When the erasure of the stored data is foreseen, use a resistor spark plug.
- Do not give any strong shock to the tachometer.
- This tachometer can not be disassembled.
- When a failure seems to be occurred, try to follow this manual properly and, still the tachometer does not work properly, contact our sale agency or our company. Do not repair nor disassemble your tachometer by yourself, because we will not guarantee any damage caused by the repair or disassembly made by yourself.

## H.Specification

Objective engine	2000DXR	Stroke	Cylinder
		2(4)	1.2
2100DXR	4	2.4	
	2/4	1 ~ 4 1 ~ 6.8	
Displaying interval	0.5sec		
Accuracy	±10rpm(20rpm for 4-stroke 1-cylinder engine ±100rpm in dual display mode.)		
Maximum R.P.M	Measured and stored.		
Cumulative time display	TEMPORARY 0 : 00 → 999 : 59 (H) : (M)		
	TOTAL 0000 : 00 → 9999 : 59 (H) : (M)		
Battery life	Approx. 20,000 hr (Measuring hour)		
Working and Storage temperature range	-20°C to +60°C		
Dimensions	44 × 61 × 12mm		
Maine unit weight	30g		
Accessories	One antenna lead wire, One magic tape (Velcro tape), and One instruction manual.		